

# 目錄

contents

## 大方牌 / DA FANG 伸縮門系列產品

FOLDING GATE SERIAL PRODUCTS

<input type="checkbox"/> 簡介 / 產品	_____	p1
<input type="checkbox"/> 封板介紹	_____	p3
<input type="checkbox"/> 凱旋門	_____	p5
<input type="checkbox"/> 羅馬門	_____	p7
<input type="checkbox"/> 凌冠門	_____	p9
<input type="checkbox"/> 藝術型	_____	p11
<input type="checkbox"/> 富麗型	_____	p13
<input type="checkbox"/> 富美型 & 富豪型	_____	p21
<input type="checkbox"/> 典雅型	_____	p22
<input type="checkbox"/> 圓型	_____	p23
<input type="checkbox"/> 美雅型	_____	p29
<input type="checkbox"/> 籬笆門	_____	p30
<input type="checkbox"/> 大門安裝說明	_____	p31
<input type="checkbox"/> 伸縮門規格表	_____	p32

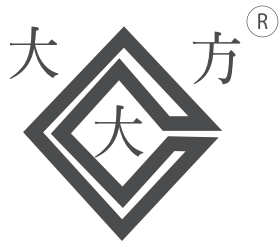

大方牌

伸縮門系列產品

大門自動好開啟  
方圓百里眾皆知

大方重新發明了「大門」  
大門不再只是出入口  
是門面·品味的展現

大方有個夢想  
希望每一戶人家  
都有一扇歸屬感的大門

## 產品特色 / 傳統型、經典、精品型 /



### 工業專用馬達 - 帶動大門毫不費力

本驅動採用特殊設計之直立式蝸輪減速機及工業專用馬達，配合免加重自動迴正馬達座，馬達座上完全不用加重物即能順暢帶動大門，相較之下，他牌一般文電馬達無散熱裝置易跳機且重量輕帶動時易空轉，大方牌工業專用馬達帶動力量更大，更順暢，整體造型更美觀。



### 全國唯一通過SGS認證的不鏽鋼碰停裝置 - 大門安全的最佳把關

大方牌伸縮門配置的碰停安全裝置，為全國唯一通過SGS認證的碰停安全裝置，當碰到異物約5-6KGW的撞擊力時，門就立即停止，大門使用安全更有保障，此外，碰停裝置螺絲配件全為不鏽鋼材質，堅固耐用，大門安全不因時間流逝有任何妥協。



### 個性化造型封板 - 高貴不貴新選擇

大方牌提供一系列的個性化造型封板，採用精密電腦加工，外型美觀大器，讓您的伸縮門與眾不同，高貴不貴的新選擇。



### 不鏽鋼防風輪 - 抗颱風先鋒

大方牌推出不鏽鋼防風輪，當伸縮門位於強風處時可選購加裝防風輪，防止強風吹倒，滑行順暢，防風輪、軸心、軸承皆為不鏽鋼材質，堅固耐用。



### 完善售後服務網路 - 一年保固、終生服務

大方牌伸縮門銷售網路遍布全國，出廠的每座伸縮門都有專屬編號，如有故障請立即與在地經銷商聯繫並告知大門編號，大方牌擁有8位外勤維修服務技師，不分北中南皆到府服務，效率業界第一。

※ 大方牌伸縮門提供出廠一年保固，天災人為除外



### 手機APP遠端遙控 - 物聯網智慧型伸縮門

不必加裝繁複系統，只要使用家中的 Wi-Fi 即可以和雲端連線，升級為物聯網智慧伸縮門。手機APP遠端遙控與即時通知，工廠員工或家族成員均可分享使用，不必擔心遙控器遺失或被盜拷；家人忘了帶遙控器，人在外地也可以幫忙開門。



# 封板沖孔樣式

## • 3D浮雕

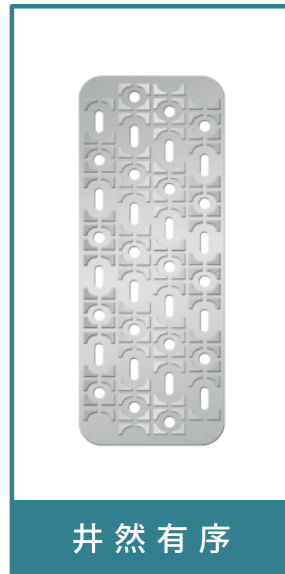

材質：不鏽鋼板、鍍鋅板

## • 基本沖孔

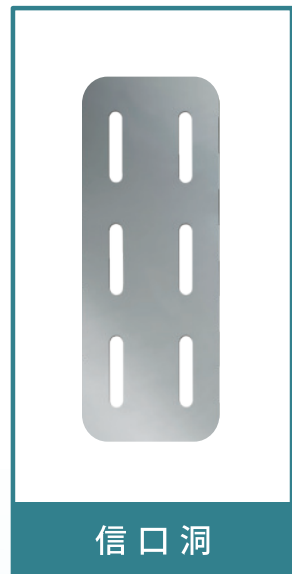
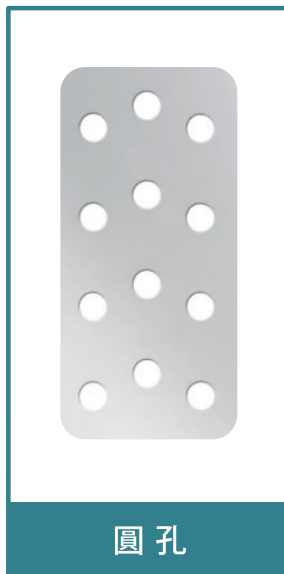

※ 封板高度：600、750、1000、1350、1500、1750

材質：不鏽鋼板



# 細部圖

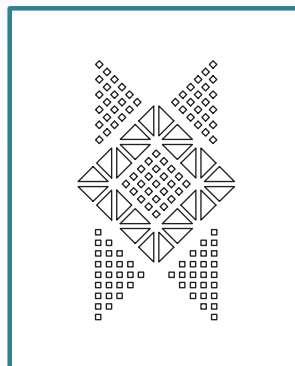

扶搖直上

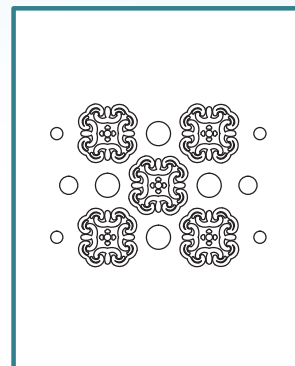

金碧輝煌

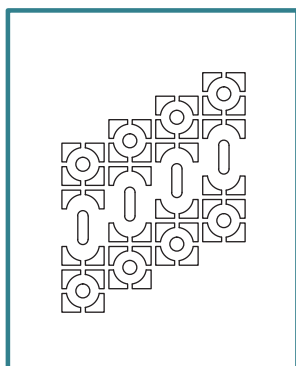

井然有序

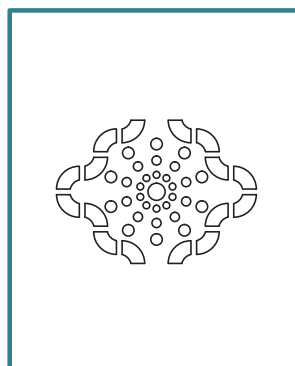

撥雲見日

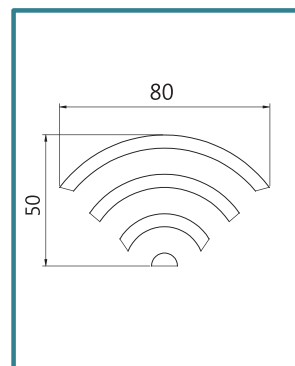

步步高昇

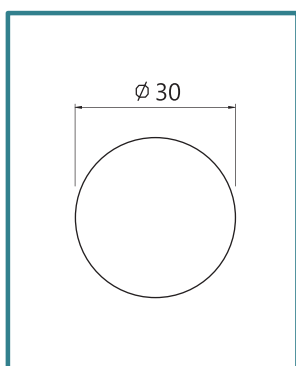

圓孔

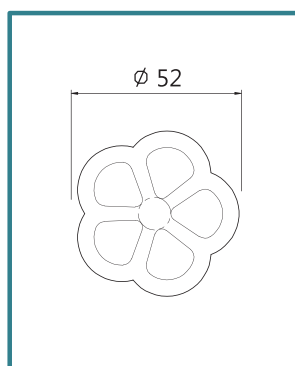

花團錦簇

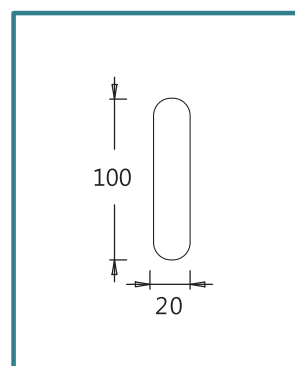

信口洞

# 凱旋門



收合圖



單位：mm

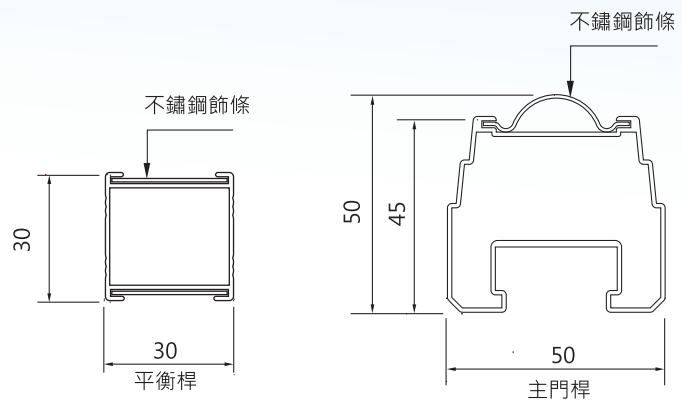

### 材料規格

※ 凱旋門可做透空、半密、全密等樣式

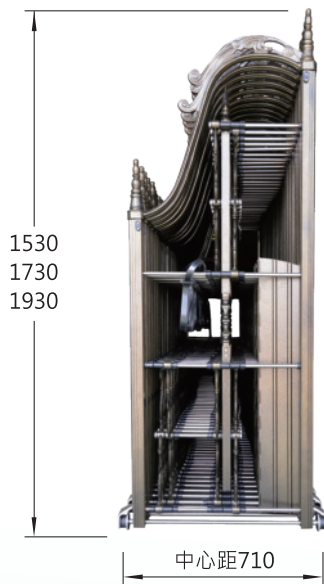

側面圖

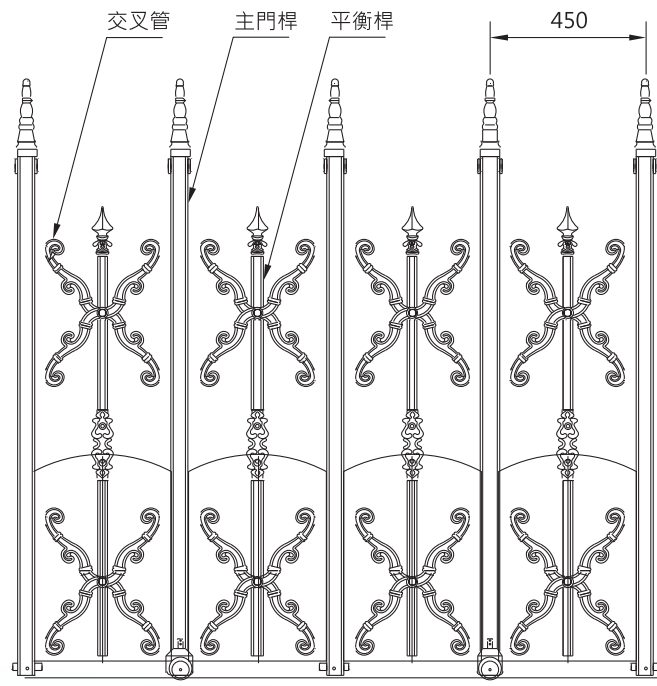

材料規格



# 羅馬門



## 一體成型滑槽

滑槽設計採一體成型，  
較堅固、不易脫落、造型美觀。



單位：mm

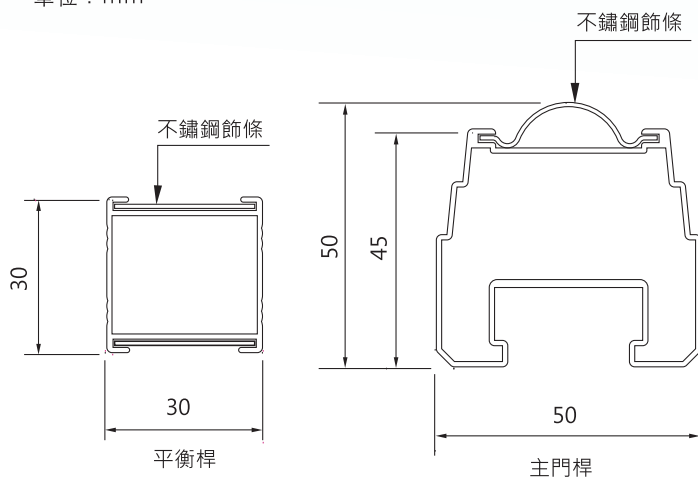

收合圖

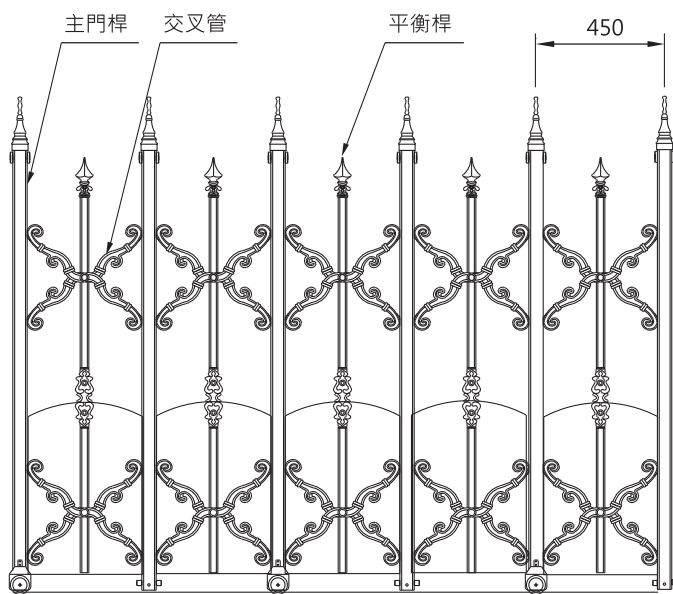

材料規格



側面圖

※羅馬門可做透空、半密、全密等樣式



# 凌冠門

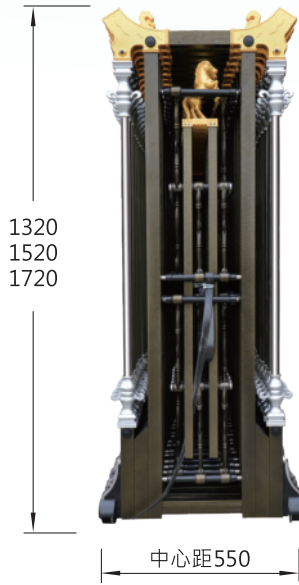

側面圖



收合圖

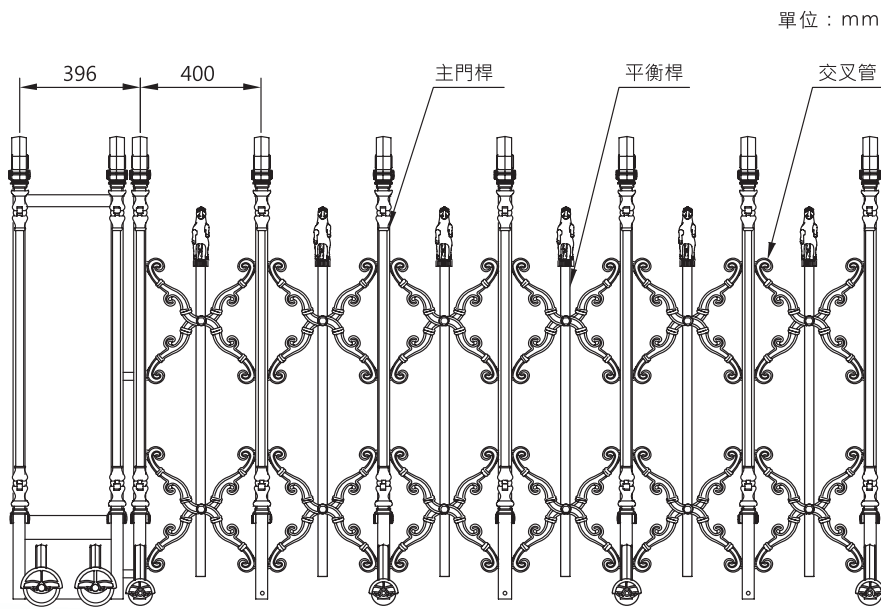

材料規格





※ 古銅色門桿，搭配金、銀飾品



金馬風格，氣派饗宴

#### 大門細部圖

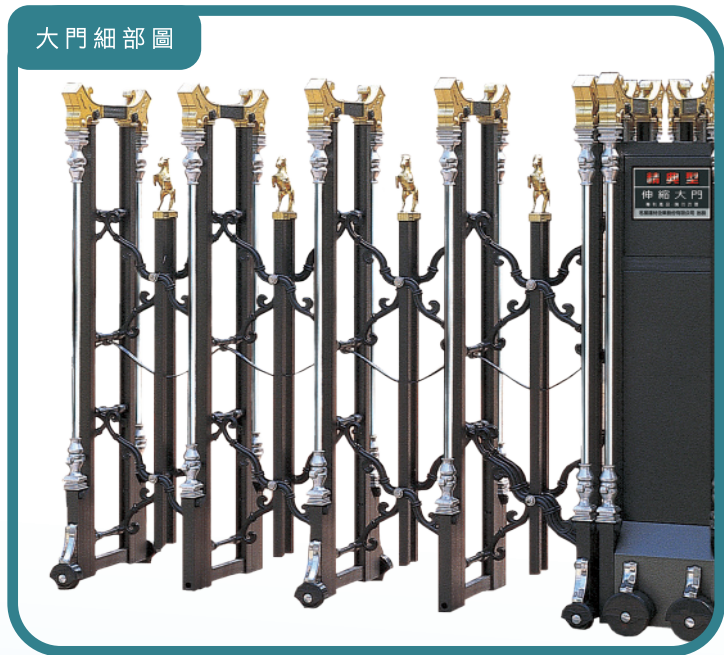



# 藝術型



金碧輝煌

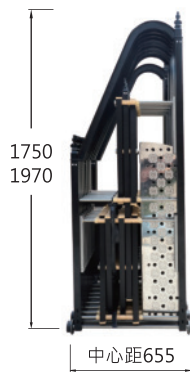

側面圖



收合圖



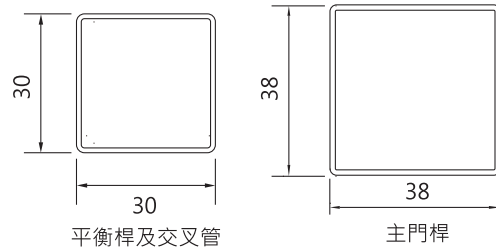

單位：mm

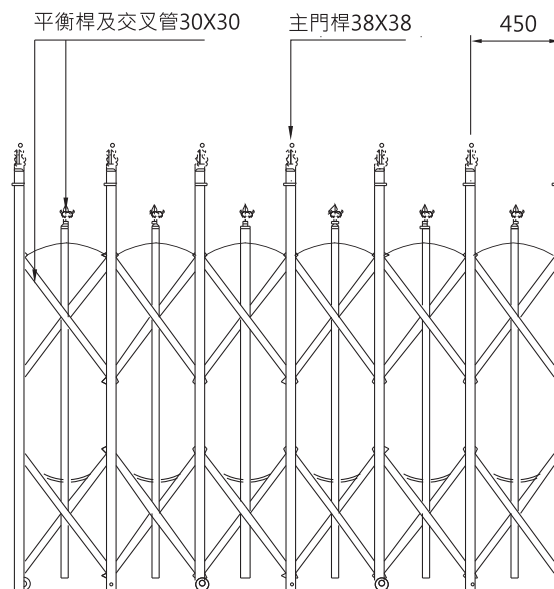

細部圖



※ 藝術型可做透空、半密、全密等樣式

※ 材質：不鏽鋼、鋁合金、黑鐵烤漆



# 富麗型





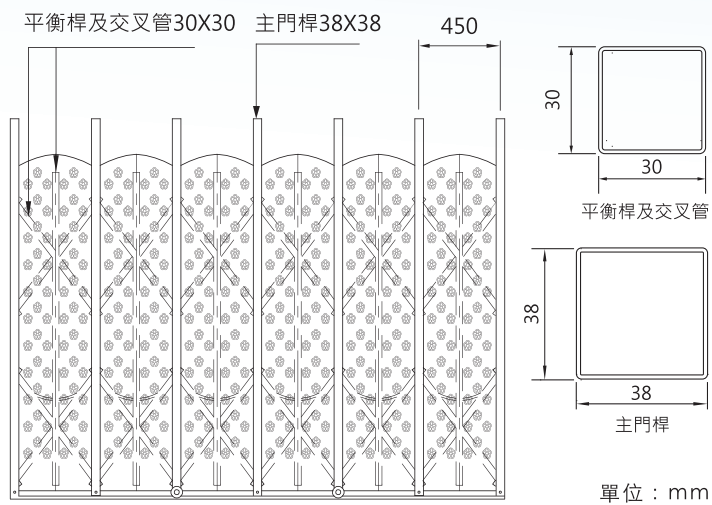

材料規格



花團錦簇

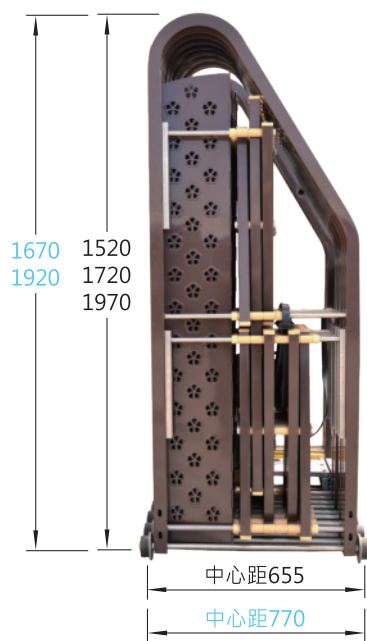

側面圖



收合圖

※ 富麗型可做透空、半密、全密等樣式

※ 材質：不鏽鋼、鋁合金、黑鐵烤漆

# 富麗型

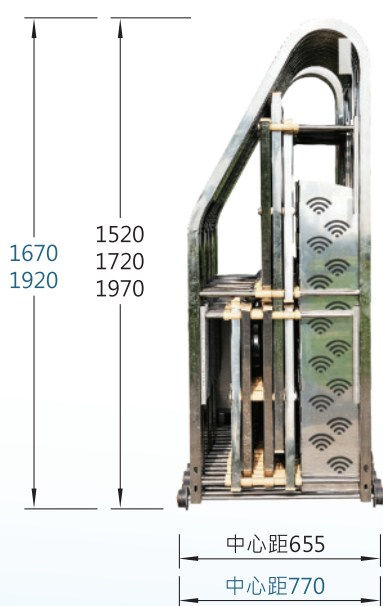

側面圖



步步高昇



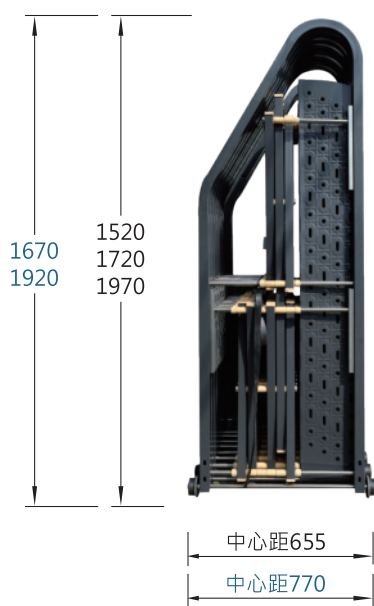

側面圖



井然有序

※ 富麗型可做透空、半密、全密等樣式    ※ 材質：不鏽鋼、鋁合金、黑鐵烤漆

# 富麗型



交叉形交叉桿設計



單位：mm

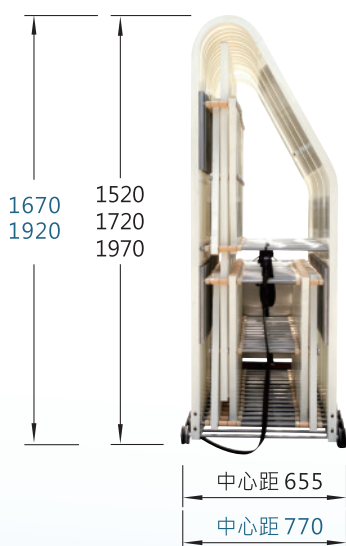
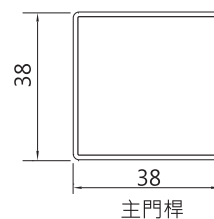
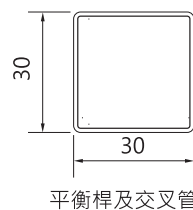

側面圖

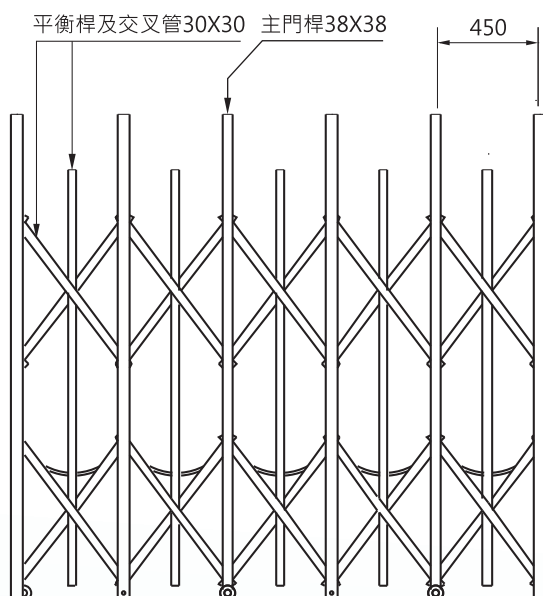

材料規格

※ 富麗型可做透空、半密、全密等樣式

※ 材質：不鏽鋼、鋁合金、黑鐵烤漆



滑槽採不鏽鋼材質

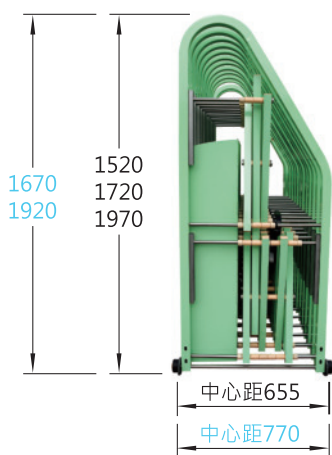

側面圖



收合圖

單位：mm

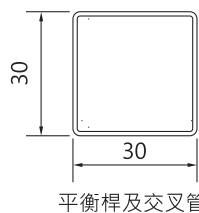

平衡桿及交叉管

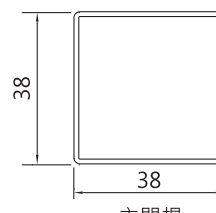

主門桿

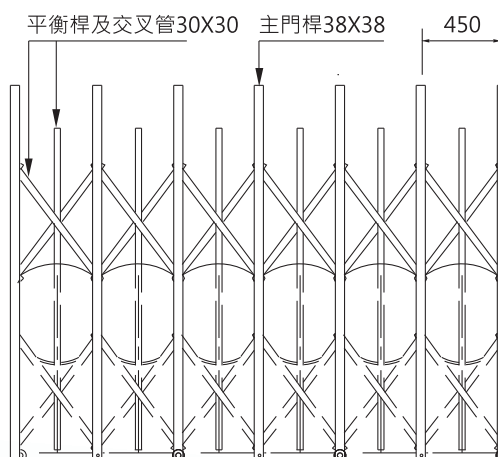

材料規格

# 富麗型



單位：mm

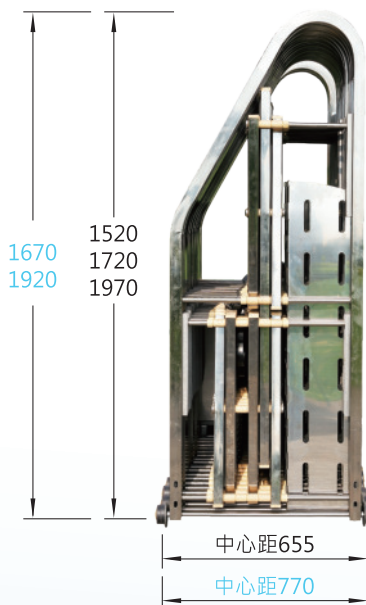
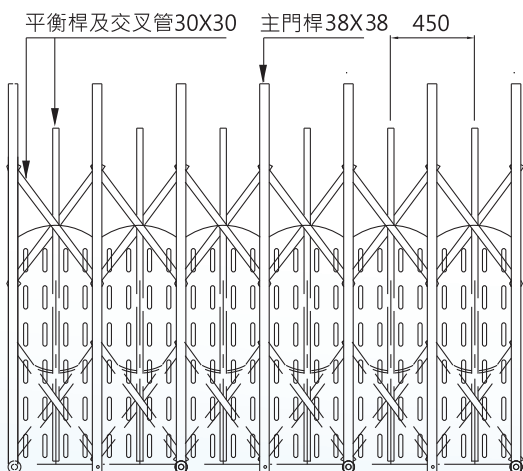
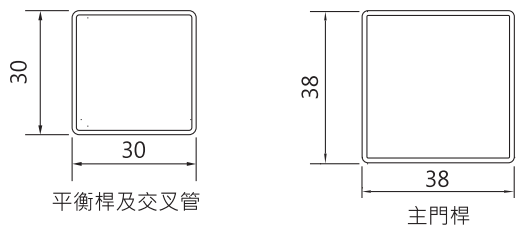

材料規格

側面圖

信口洞





人字形交叉桿設計



單位：mm



側面圖

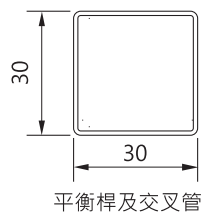

平衡桿及交叉管

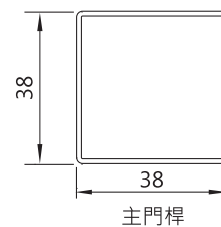

主門桿

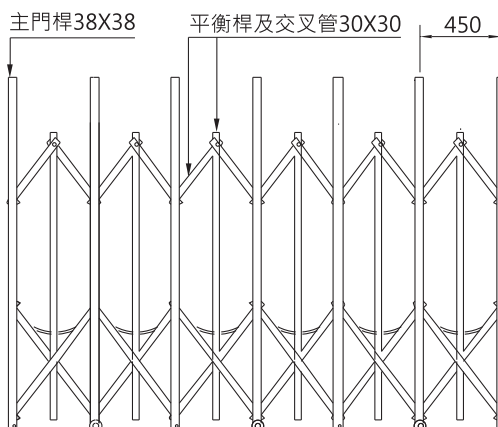

材料規格



收合圖

- ※ 富麗型可做透空、半密、全密等樣式
- ※ 材質：不鏽鋼、鋁合金、黑鐵烤漆

# 富美型 富豪型

- 隱藏式結構，收合時比一般同型大門減少一半空間。
- 滑槽採用耐陽光、耐雨之塑鋼，倒鉤隱藏型滑槽以防止滑槽內滑塊跑出槽外。



## 富美型

單位：mm

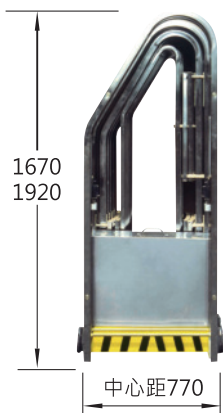

側面圖



收合圖

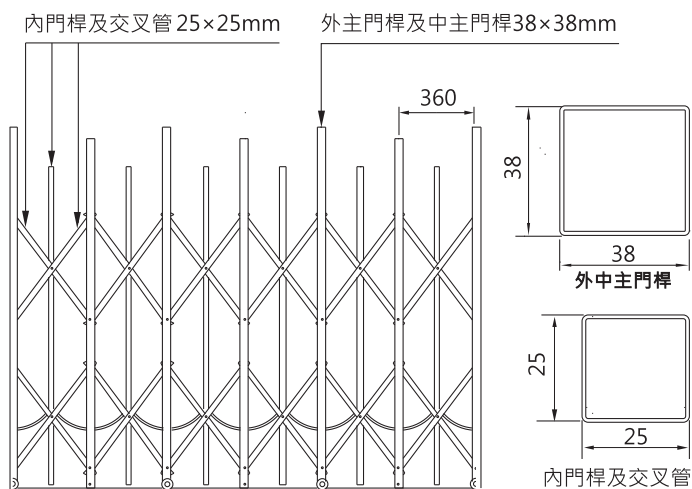

材料規格

※ 材質：不鏽鋼、鋁合金、黑鐵烤漆

## 富豪型

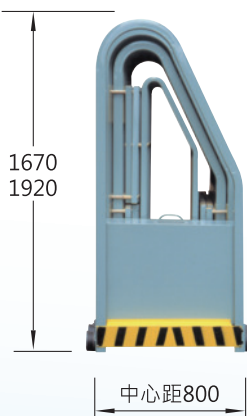

側面圖



收合圖

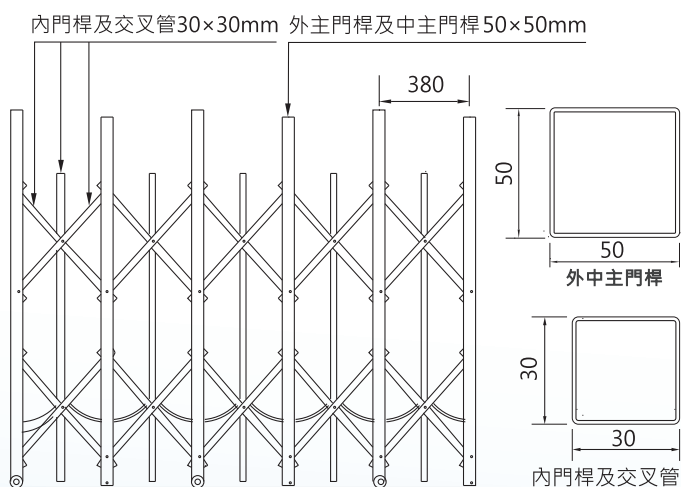

材料規格

※ 材質：不鏽鋼、鋁合金

# 典雅型



## 特色設計

※ 滑槽採用不鏽鋼材質

單位：mm

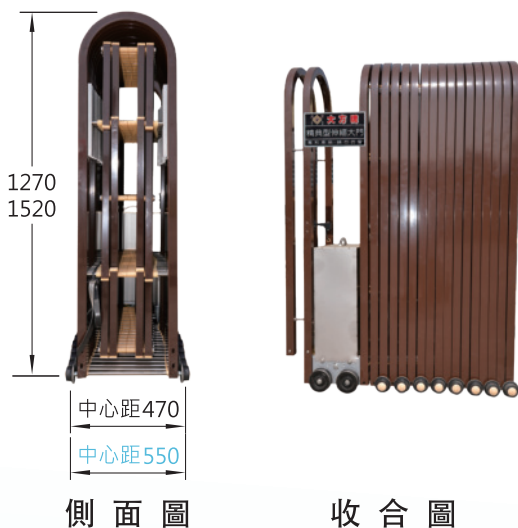
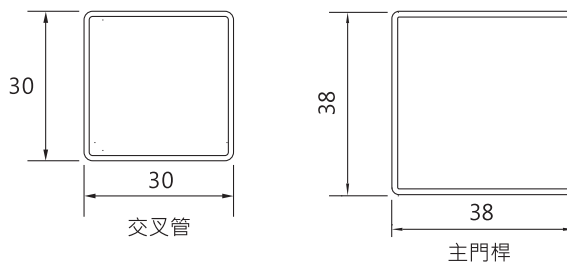

側面圖

收合圖

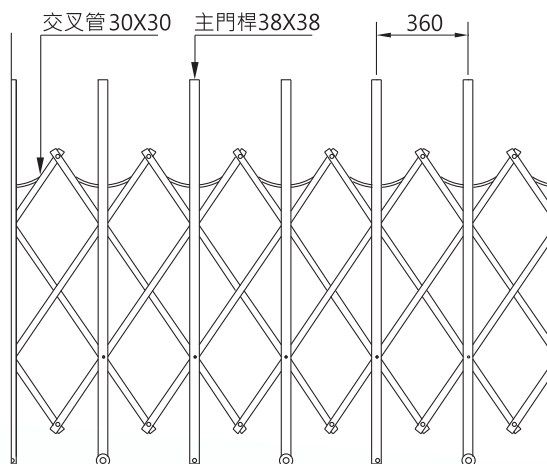

## 材料規格

※ 材質：不鏽鋼、鋁合金、黑鐵烤漆



# 圓型



步步高昇



側面圖

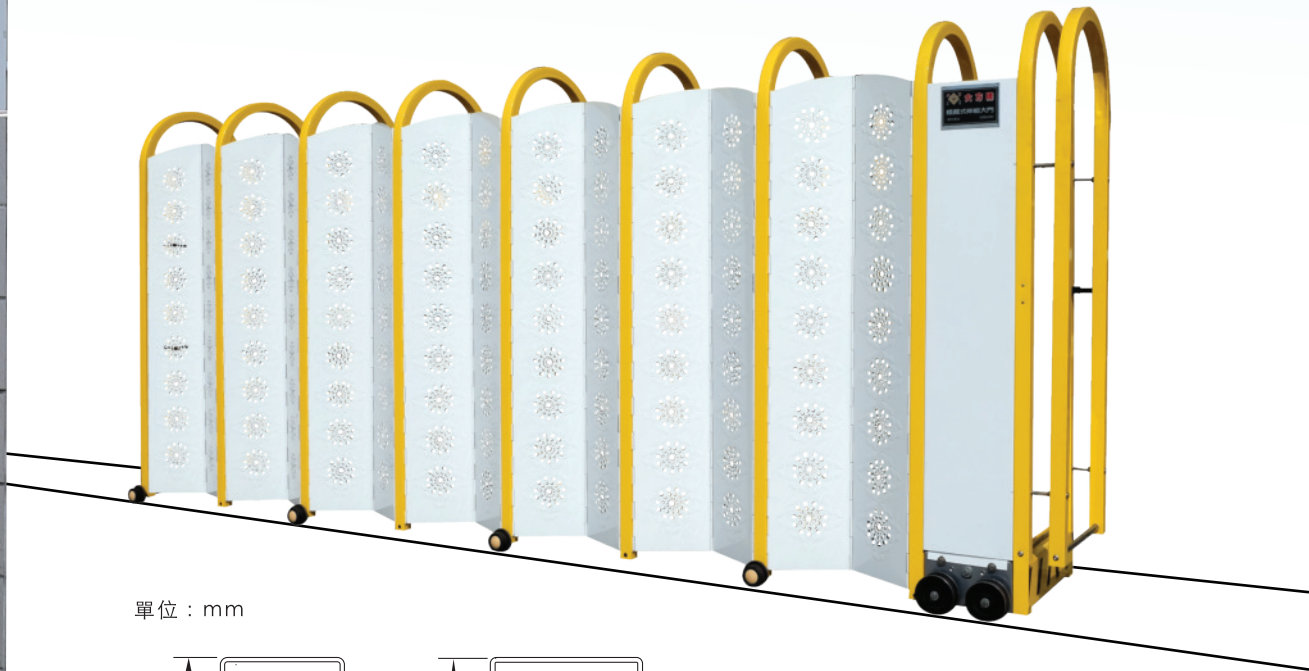

單位：mm

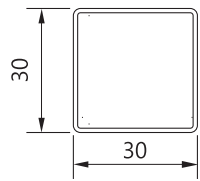

平衡桿及交叉管

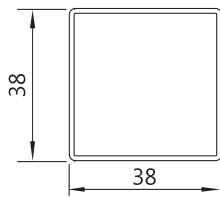

主門桿



撥雲見日

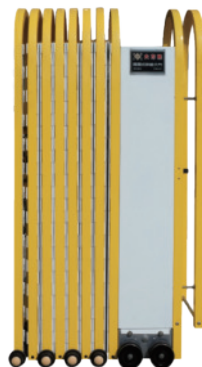

收合圖

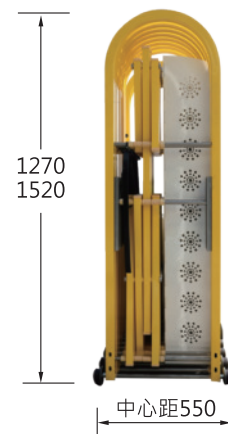

側面圖

※ 圓型可做透空、半密、全密等樣式

※ 材質：不鏽鋼、鋁合金、黑鐵烤漆



# 圓型



圓孔

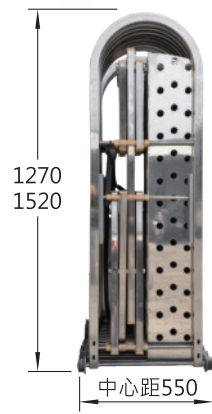

側面圖

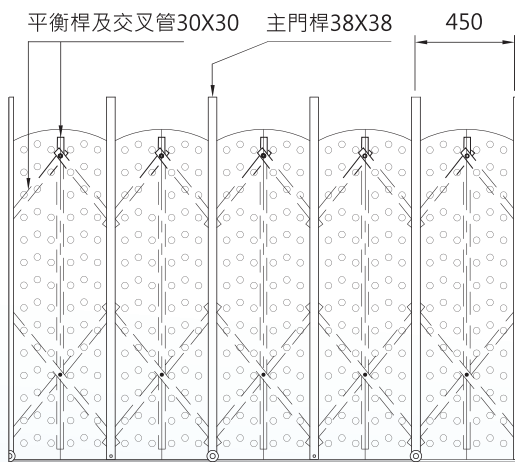

單位：mm

材料規格



收合圖

# 圓型



花團錦簇

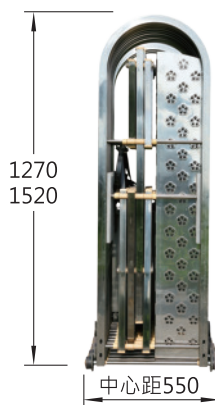

側面圖

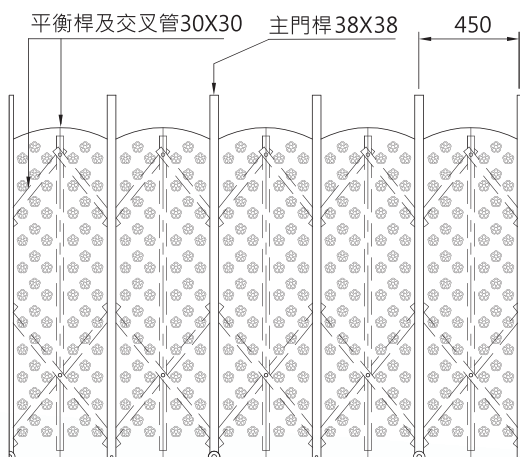

材料規格

單位：mm



收合圖

※圓型可做透空、半密、全密等樣式  
 ※材質：不鏽鋼、鋁合金、黑鐵烤漆

# 圓型

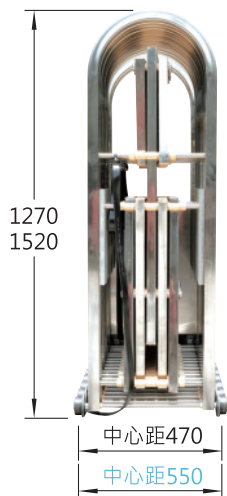

側面圖

單位：mm

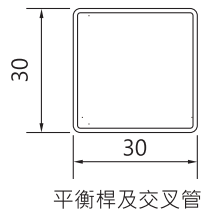

平衡桿及交叉管

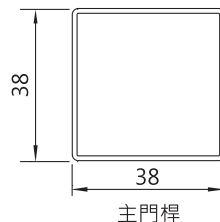

主門桿

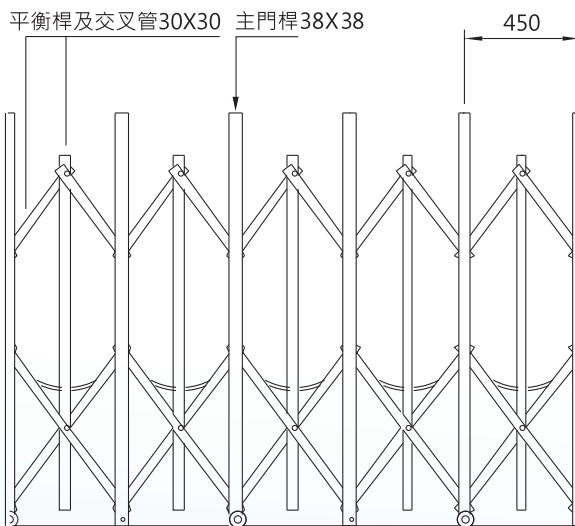

材料規格



收合圖



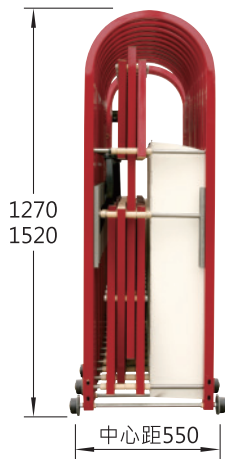

側面圖

單位：mm

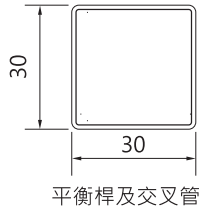

平衡桿及交叉管

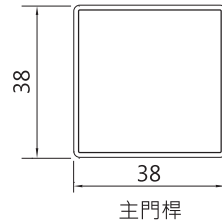

主門桿



收合圖

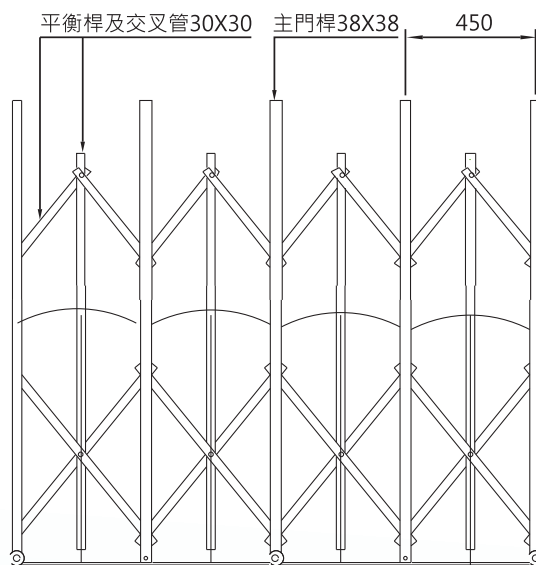

材料規格

- ※ 圓型可做透空、半密、全密等樣式
- ※ 材質：不鏽鋼、鋁合金、黑鐵烤漆

# 美雅型

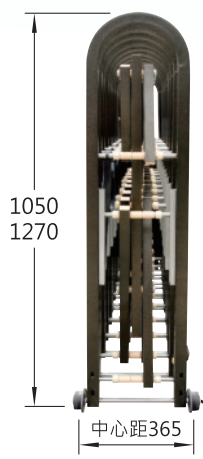

側面圖



單位：mm

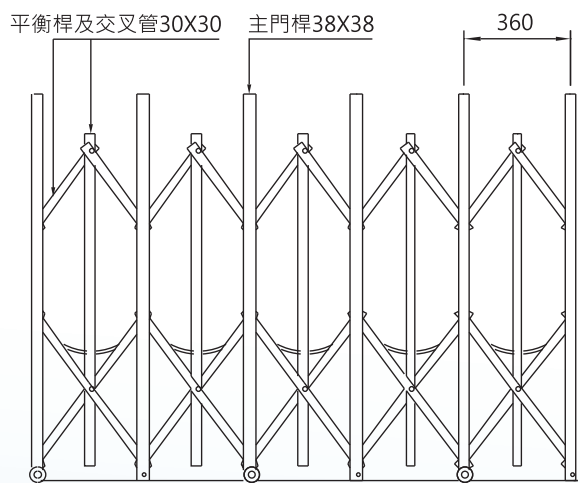
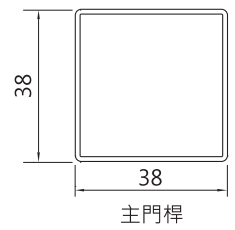
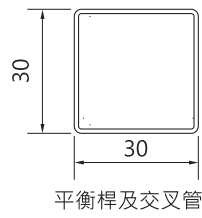

## 材料規格



收合圖

※ 材質：不鏽鋼、鋁合金、黑鐵烤漆

# 籬笆型

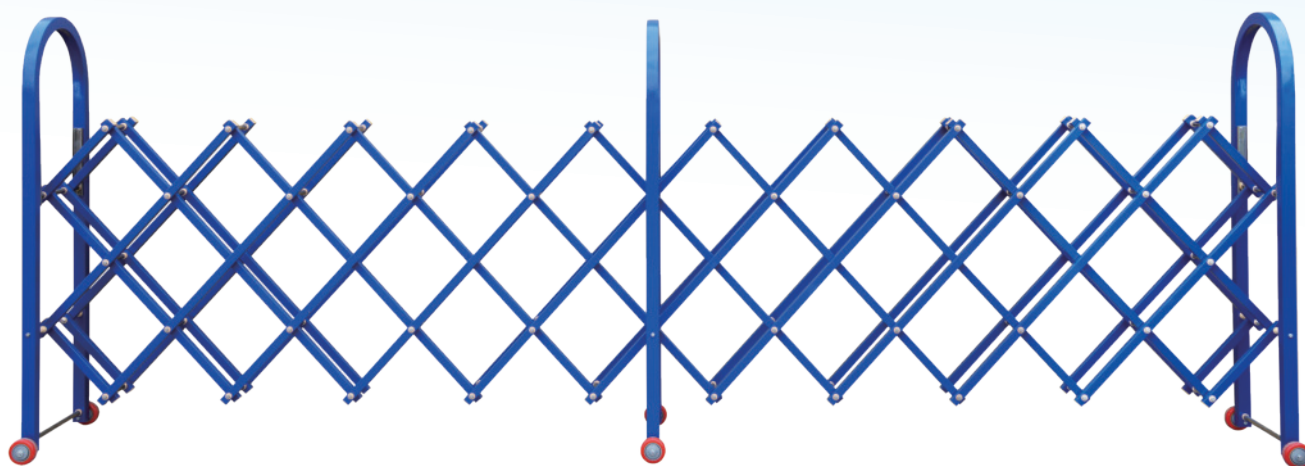

單位：mm

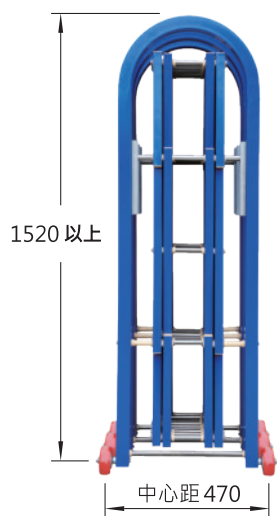
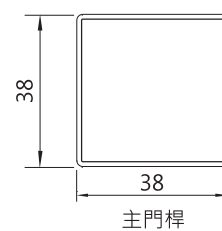
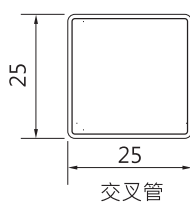

側面圖

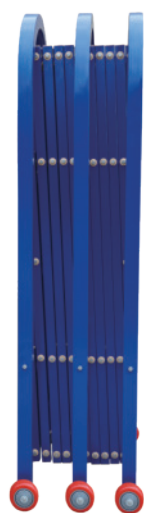

收合圖

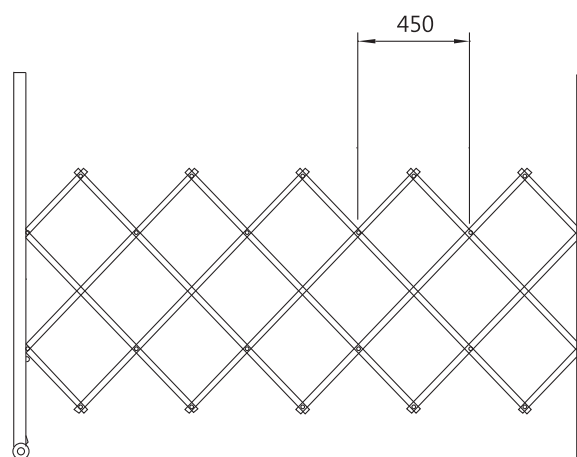

材料規格

※ 材質：不鏽鋼、鋁合金、黑鐵烤漆

# 大門長度測量須知

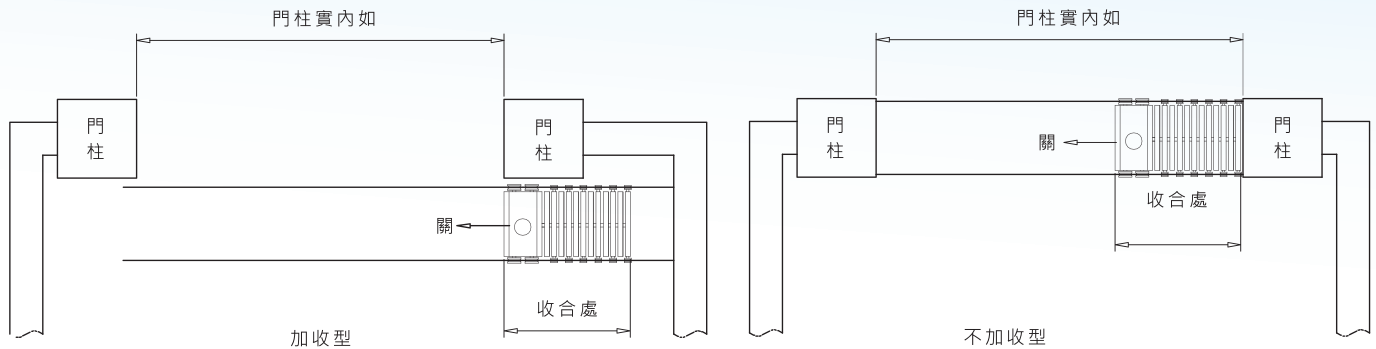

## 大門安裝說明

1. 將軌道上雜物及水泥清除乾淨，之後把大門放置軌道上。  
【大方牌向外】
2. 將大門拉開核對長度及收合寬度是否正確。
3. 將最前面兩支大柱間的保麗龍取下，將門後電源線【藍線與黑線】接上，再將斑馬線板取下，送電後確認斑馬線板上標示的前進及後退的微動開關是否正確、碰停開關是否正常。  
【碰停開關的作用是大門前進時碰到東西停下來】
4. 確定完成之後即可固定前進與後退檔片，檔片需與軌道平行。

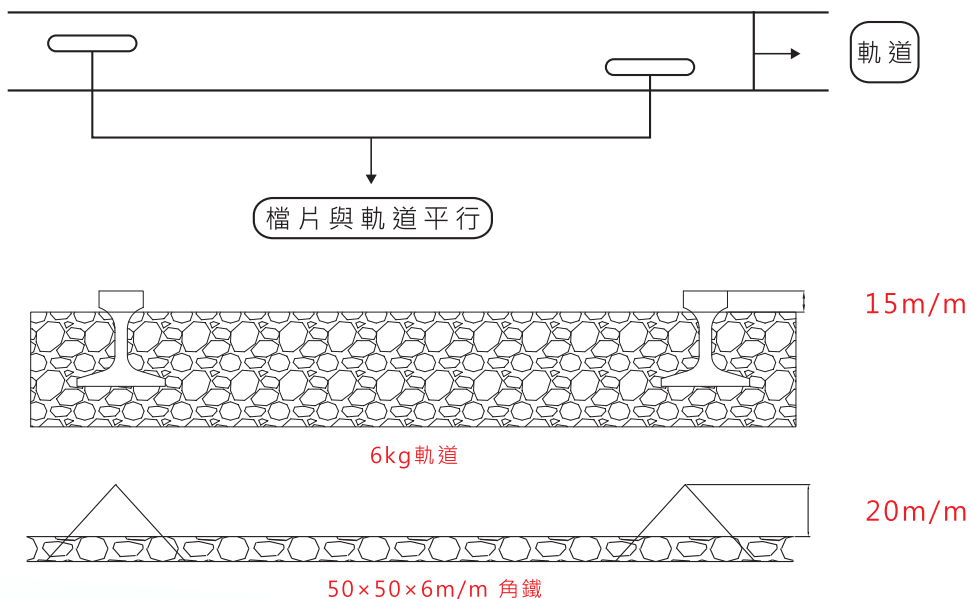

5. 碰停確定沒問題後，開始固定大門後的固定片。【固定片為長條型的白鐵】
6. 向本廠購新門，須請有證照電工安裝漏電斷電器於電源源頭，不能潮濕及淋到雨，不可與其他用電共用，需讓該門專用。  
【備註：如果是三相電源，碰停沒有作用時，請將門後電源第1條與第3條交換即可《中間電源不動》】

大鈺金屬企業有限公司 名星建材企業股份有限公司

門桿寬度、支數、收合寬度表

門柱間距36公分適用			門柱間距45公分適用			富美型適用		
門桿支數 (含馬達)	門寬 (CM)	收合寬度 (含馬達) CM	門桿支數 (含馬達)	門寬 (CM)	收合寬度 (含馬達) CM	門桿支數 (含馬達)	門寬 (CM)	收合寬度 (含馬達) CM
11	348	86	12	474	91	11	353	54
12	384	91	13	519	97	12	389	58
13	420	97	14	564	102	13	425	60
14	456	102	15	609	108	14	461	63
15	492	108	16	654	113	15	497	65
16	528	113	17	699	119	16	533	69
17	564	119	18	744	124	17	569	71
18	600	124	19	789	130	18	605	75
19	636	130	20	834	135	19	641	77
20	672	135	21	879	141	20	677	80
21	708	141	22	924	146	21	713	82
22	744	146	23	969	152	22	749	86
23	780	152	24	1014	158	23	785	88
24	816	157	25	1059	163	24	821	92
富豪型適用			凱旋 / 羅馬門適用			凌冠門適用		
門桿支數 (含馬達)	門寬 (CM)	收合寬度 (含馬達) CM	門桿支數 (含馬達)	門寬 (CM)	收合寬度 (含馬達) CM	門桿支數 (含馬達)	門寬 (CM)	收合寬度 (含馬達) CM
11	374	64	12	474	108	12	400	111
12	412	67	13	519	115	13	440	118
13	450	70	14	564	122	14	480	126
14	488	73	15	609	129	15	520	133
15	526	76	16	654	136	16	560	141
16	564	80	17	669	143	17	600	148
17	602	83	18	744	150	18	640	156
18	640	87	19	789	157	19	680	163
19	678	90	20	834	164	20	720	171
20	716	94	21	879	171	21	760	178
21	754	97	22	924	178	22	800	186
22	792	101	23	969	185	23	840	193
23	830	104	24	1014	192	24	880	201
24	868	108	25	1059	199	25	920	208

·傳統大門加碰停收合位需加10CM



## 關係企業

Affiliates



名流建材企業  
股份有限公司

主要產品 防火門

企業網站 <http://www.mingliou.com.tw>

大門自動好開啟  
方圓百里眾皆知

追求卓越品質 · 滿足顧客需求

For the excellence of quality and the satisfaction of customer

經銷商

Made In Taiwan  
Prestige Worldwide

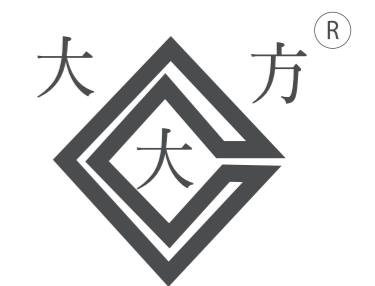

[www.dafang.com.tw](http://www.dafang.com.tw)

**大方牌** DA FANG  
Floding Gate Serial Products

伸縮門系列產品

台灣製造 · 名揚國際

大鈞金屬企業有限公司 | 出品  
名星建材企業股份有限公司

■ 本產品全部零配件皆為台灣設計 · 製造